



**KAPRO**<sup>®</sup>  
TOOLS WITH VISION

**CATALOG**  
**2017**



**KAPRO**<sup>®</sup>  
TOOLS WITH VISION

**LEVELS | LASERS | LAYOUT & MARKING**

## **OUR CORPORATE VISION**

**Kapro brings the world Tools with Vision™, products that are market leaders in excellence, innovation, design, quality, and value.**

**Kapro is a source of growth, pride, identification, and well-being for all of its partners: customers, staff, suppliers, shareholders, and the communities in which we live.**

**Kapro diligently protects the environment for future generations.**

**Kapro represents excellence and success, throughout the world.**

### **TO OUR SHAREHOLDERS**

Kapro will always act to maximize our shareholders' long term return on capital. This aim will be achieved through fair and ethical business practices.

Kapro will operate with transparency and accountability.

### **TO OUR STAFF**

The cornerstone of the relationship between Kapro and its staff is the identification with our shared company and our mutual goals.

Kapro will act to fulfill the potential that exists in each staff member, to encourage dedication, initiative, and responsibility, and will provide our workforce with excellent work conditions, and fair remuneration for diligent work.

Kapro will maintain its family atmosphere, wherein all our employees benefit from the success of the company, with fair treatment for all.

Kapro will maintain a workplace that respects and protects the rights of all of our employees, free of harassment or discrimination.

### **TO OUR CUSTOMERS**

Kapro will be the leading supplier of layout, marking, and measuring tools to our customers.

Kapro will give our customers an advantage over their competitors by constantly listening to their requirements, providing excellent service, maintaining outstanding quality, and creating added value in our products through innovation and design.

Our vision is that the relationships between Kapro and our customers are to be friendships which will be expressed in the complete trust and openness that we shall give to, and receive from our customers.

### **TO OUR SUPPLIERS**

Kapro sees our suppliers as partners in the mission of meeting our customers' needs.

Kapro will always act fairly, cooperatively, and in coordination with our suppliers, with the aim of strengthening, deepening, and enhancing the mutual relationship.

### **TO THE COMMUNITY**

Kapro will be a leading force in improving the lives of the communities within which we operate.

Kapro will protect the physical environment of our communities for the sake of future generations.

Kapro will initiate projects that reflect our commitment to our communities, as part of our concerted efforts to integrate harmoniously into each unique environment.



## ABOUT US

**Kapro is a leading manufacturer and developer of innovative hand tools for the professional and DIY markets.** We make the industry's finest quality spirit levels, laser levels, and layout, marking and measuring tools. The company has built a reputation as the industry's foremost innovator, and is renowned for its quality products, outstanding service, added value, and cutting-edge designs.

### GLOBAL DISTRIBUTION NETWORK

**Kapro is a major global player in its category.** Headquartered in Kadarim Israel, Kapro operates facilities in Israel, China, and the USA – all wholly owned by Kapro Industries. Our network of distribution partners has created a leading market presence in over 70 countries, throughout Europe, the Americas and Asia, and in Australasia and Africa.

### INNOVATION & DESIGN

**Kapro's Innovation Team has revolutionized layout & measuring tool design and given the market some of its most ground-breaking features.**

The development of the Plumb Site® Dual-View™ changed level design forever. It is the only level feature to provide a front-on view of the plumb vial, eliminating parallax error as well as the neck and back strain that usually accompany vertical plumb jobs.

The introduction of the Optivision™ Red feature set a whole new standard in vial visibility by creating a strong color definition around the spirit level's horizontal bubble. It is the clearest and most visible vial on the market today.

In 2016 Kapro changed the game again with the release of the Swivel Plumb Site® - the newest generation in Plumb Site® vial technology.

In addition to these market-changing features Kapro has over 100 patents worldwide covering a comprehensive range of professional applications. Products such as Prolaser® Vector, Postrite® Folding Post Level, Stud Layout Level, Electricians' Level , 846 Cyclops, Set & Match® Ruler, Topgrade™ Gradient Level and many more make Kapro the smartest choice in tools.

Our unique designs are highlights by their sleek, stand-out red look, simplicity of design and eye-catching graphics and packaging. Kapro's engineering and design departments are based in Israel.





# CONTENTS



**Levels .....9**



**Lasers & Intelligent Tools .....41**



**Layout & Marking .....59**





Swivel Plumb Site

PLUMB SITE®  
DUAL-VIEW™ VIAL

180°

Swivel Plumb Site

PLUMB SITE®  
DUAL-VIEW™ VIAL

180°



### Plumb Site® Dual-View™ Vial

Unique front view of the vertical vial



### Angle Finder

Transfer angle measurements

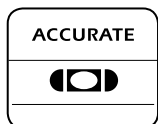

### Accuracy

Solid acrylic vials are individually calibrated

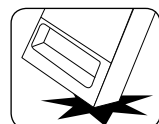

### Shockproof End Caps

Protects the level's integrity and accuracy

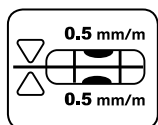

### Precision

Up to 0.5mm/m in all positions

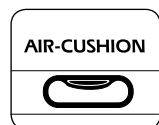

### Air-cushioned Ergo Grip™ Handles

Patented wall-grip handles with PVC air cushions

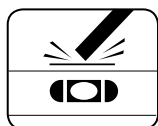

### Solid Acrylic Shockproof Vials

Superior accuracy, readability and longevity



### Magnetic

Powerful magnetic surface for accurate hands-free leveling

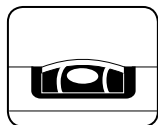

### Magnified Vial

Better readability

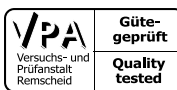

### VPA

Vial accuracy certified by the German VPA laboratory

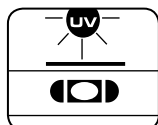

### UV Resistant

Protected from the fading effects of sunlight



### Lifetime Vial Warranty

Solid acrylic vials are guaranteed not to fog, leak or break





## **KAPRO CREATES**

### **The world's most visible vials**

By making vial visibility the heart of its quest for excellence, Kapro tools offer a clear advantage and are changing the way the professional contractor uses a level.

### **OPTIVISION™ RED**

#### **A new level of visibility**

**OPTIVISION™** is a Kapro invention that creates the effect of a strong red color definition around the spirit level's horizontal bubble, in stark contrast to the white vial background and clear liquid.

The color contrast makes the bubble edges significantly easier to see –even in low or bright light – for fast and accurate placement between the reading lines.

### **SWIVEL PLUMB SITE™**

#### **The Total Plumb View**

The top-down view of a level's vial is the most accurate. Until Kapro invented the Plumb Site™ Dual View, that was impossible on the vertical plumb vial.

Now, Kapro's 2nd generation Swivel Plumb Site™ takes this innovative feature to a whole new level by giving you a clear top-down view from a 180° horizontal and 140° vertical range. The perfect and most precise reading view regardless of whether the level is high above your head or in a difficult to reach corner. No twisting your neck and body - just position the level and read. Easy, safe & accurate!

**Kapro Levels - Visibly Better**



990 ZEUS™ The Best Level on Earth™



- 2 Plumb Site® Dual-View™ Vial
- 1 magnified horizontal solid acrylic vial
- Keflon™ anti-stick coating
- 2 finely milled surfaces on lengths up to 120cm (48")
- Ergonomic "Air-cushioned" handles
- Patented Ergo Grip™ non-slip feature
- Bridge at horizontal vial for increased toughness and a continuous marking surface

- Polypropylene and TPR end caps with "air-cushioned" shock absorbers
- Accuracy: < 0.5 mm/m (0.0005 in/in.)

**Optional**

- Rare-Earth magnets (990M)
- Available in 12 piece display

Inch	24	32	36	40	48	60	72	80	96
Centimeter	60	80	90	100	120	150	180	200	250



# 995 VULCAN™ The Next Generation



Patented

890g/m



Inch	24	32	36	40	48	60	72	80
Centimeter	60	80	90	100	120	150	180	200

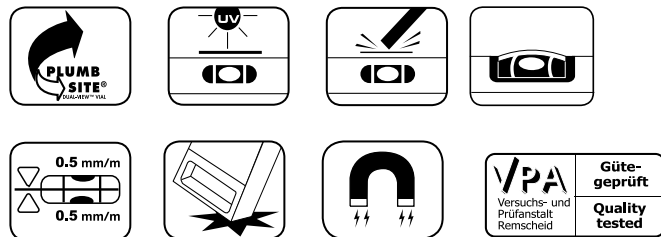

- 2 solid acrylic vertical vials with 1 Plumb Site® Dual-View™ vial
  - 1 magnified horizontal solid acrylic vial for a clear view of the bubble
  - Accuracy: <math><0.0005\text{in/in}</math>. (0.5 mm/m)
  - 2 finely milled surfaces with V-Groove for pipe measurements up to 120cm (48")
  - Reinforced profile to maintain accuracy in tough work conditions
  - Rubber shockproof end caps to protect the level's integrity
  - Ergonomic bi-material handle for a comfortable grip
- Optional**
- Magnets (995M)
  - Available in 12 piece display



**905 CONDOR™** The Professional Box Level with **OPTIVISION™ Red**



- 2 solid acrylic shockproof vials:
  - 1 OPTIVISION™ Red horizontal vial creates highly visible red bubble edges
  - 1 Plumb Site® Dual-View™ vial with RedEffect™
- Tilted horizontal vial with a direct line of sight for easy viewing
- Gradient lines for slope measurements up to 2%
- Bridge at horizontal vial for increased toughness and a continuous marking surface
- Oversized shock-absorbing rubber end caps with wall-grip feature
- Ergo Grip™ rubber handle
- Finely milled surface up to 120cm (48")
- Accuracy: <math><0.5\text{ mm/m}</math> (0.0005 in/in.)

Inch	24	32	36	40	48	60	72	80
Centimeter	60	80	90	100	120	150	180	200

**Optional**

- Magnets (905M)
- Available in 12 piece display

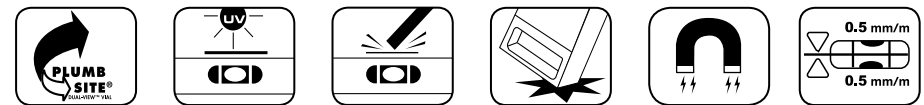

# 985 XL APOLLO™ Heavy-Duty Professional Box Level



Patented

870g/m



Inch	16	20	24	32	40	48	60	72	80	96
Centimeter	40	50	60	80	100	120	150	180	200	250

- 3 solid acrylic, epoxy locked vials, including:
  - 1 Plumb Site® Dual-View™ vial
  - 1 horizontal magnified vial
- 2 milled surfaces on lengths up to 120cm (48")
- Shock absorbing bi-material end caps
- Ergo Grip™ non-slip handles
- Accuracy: <math><0.5 \text{ mm/m}</math> (0.0005 in/in.)

**Optional**

- Magnets (985M)
- Available in 12 piece display

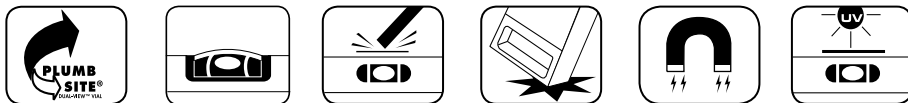

# 789P GENESIS™ Contractor Box Level



- 2 or 3 solid acrylic epoxy locked vials, including 1 Plumb Site® Dual-View™ vertical vial
- Milled surface on lengths up to 120cm (48")
- Shock absorbing rubber end caps
- Accuracy: <math><0.5\text{ mm/m}</math> (0.0005 in/in.)

**Optional**

- Magnetic Plumb Site® model: 789PM
- Without Plumb Site®: 789, 789M
- Lightweight model: 789L
- Available in 12 & 24 piece display

Inch	12	16	20	24	32	40	48	60	72	80	96
Centimeter	30	40	50	60	80	100	120	150	180	200	250

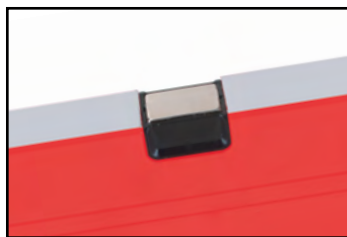
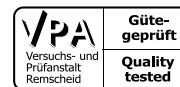



# 779 SPIRIT™ Quality Box Level



571g/m

Inch	8	12	16	20	24	32	40	48	60	72	80
Centimeter	20	30	40	50	60	80	100	120	150	180	200

- 2 or 3 solid acrylic vials
- Milled surface on lengths up to 120cm (48")
- Shock absorbing rubber end caps
- Wall grip feature
- Accuracy: <math><0.5 \text{ mm/m}</math> (0.0005 in/in.)

- Optional**
- Magnetic model: 779M
  - Available in 30 piece dispenser display (8"/20cm)

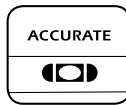
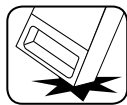
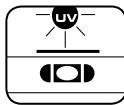

0.5mm/m (0.0005in/in.)

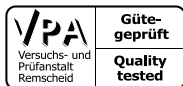

# 773 DRYWALL LEVEL 90cm



- Aluminum box level profile with stud slots and markers for standard stud layout
- Stud slots with rare-earth magnets – insert and hold metal studs for quick and easy moving and setting
- Find studs behind drywall sheets with layout markers on the level's side
- Epoxy locked, solid acrylic vials:
  - 1 Plumb Site® Dual-View™ vertical vial
  - 1 horizontal vial
- Magnetic milled surface
- Shockproof end caps
- Accuracy: < 0.5mm/m (0.0005 in/in.)

2 options for standard stud layout:

773	400mm	600mm
773 G	417mm	625mm

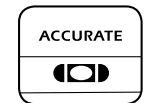
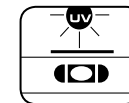

0.5mm/m (0.0005in/in.)

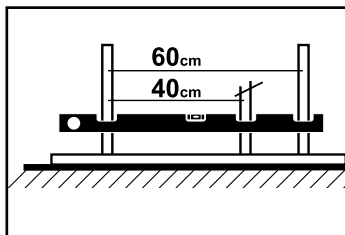

# 770 EXODUS The Ruler in Levels



2.5cm (1")



6cm (2.4")

880g/m

Inch	24	32	40	48	60	72
Centimeter	60	80	100	120	150	180

- 3 solid acrylic shockproof vials:
  - Horizontal with gradient lines up to 2%
  - Vertical and 45°
- Finely milled surface (up to 120cm)
- Shock absorbing rubber end caps
- Accuracy: < 0.5 mm/m (0.0005in/in.)
- Wall grip feature

**Optional**

- Available in 12 piece cardboard display

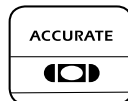
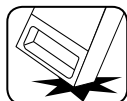
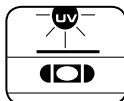

0.5mm/m (0.0005in/in.)

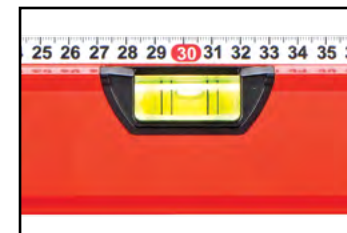



# 170 SAMSON™ Contractor I-Beam Level



Patented

842g/m

- 3 cylindrical vials (horizontal, vertical, optional 45°), including 1 Plumb Site® Dual-View™ vial
- 2 milled surfaces on lengths up to 120cm (48")
- Heavy-duty aluminum frame
- Shock absorbing rubber end caps
- Ergonomic rubber handle
- Accuracy: < 1mm/m (0.001 in/in.)

**Optional**

- Magnets (170M)

Inch  
Centimeter

16	24	32	36	40	48	72	80
40	60	80	90	100	120	180	200

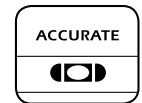
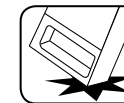

1mm/m (0.001in/in.)



## 150 I-BEAM LEVEL Quality I-Beam Level

Patented

 610g/m



2.5cm (1")

5.8cm (2.3")

Inch	16	20	24	32	40	48	60	72	80
Centimeter	40	50	60	80	100	120	150	180	200

- 3 cylindrical vials, including:
  - 1 Plumb Site® Dual-View™ vial
  - Angle finder vial
  - Horizontal vial

### Optional

- Angle finder
- Magnet (159M)

- V-groove base for easily leveling pipes
- Sturdy aluminum frame



## 130 I-BEAM LEVEL Value I-Beam Level

5.5cm (2.2")



- 2 or 3 easy-to-read vials (horizontal, vertical, 45°)
- V-groove base for pipe/conduit

- Comfortable hand grip
- ABS end caps

Inch	12	16	20	24	32	40	48
Centimeter	30	40	50	60	80	100	120

 450g/m

# 950 SWIVEL PLUMB SITE® 45 cm



The Swivel Plumb Site® saves you time with a 5x wider view of the vertical vial and is more accurate with a top-down view from any position.

- 3 solid acrylic epoxy locked vials, including:
    - 1 horizontal
    - 1 standard vertical
    - 1 vertical vial with the Swivel Plumb Site® feature
  - Ultra-durable high pressure cast aluminum profile
  - Oversized Shock-proof end caps with Anti-Slip feature
  - Accuracy: 0.5mm/m (0.0005in/in.)
  - Milled surface
- Optional**
- Magnet (950M)

ACCURATE 	<b>VPA</b> Versuchs- und Prüfanstalt Remscheid <b>Güte-geprüft</b> <b>Quality tested</b>	

0.5mm/m (0.0005in/in.)



# 930 SMARTCAST™ Professional Mason's Level with OPTIVISION™ Red



Patented



5.5cm (2.2")

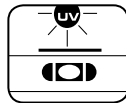

0.5mm/m (0.0005in/in.)

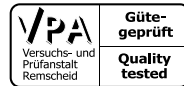

Inch	16	24	32
Centimeter	40	60	80
	510g	765g	950g

- 2 solid acrylic shockproof vials, including:
  - OPTIVISION™ Red horizontal vial creates highly visible red bubble edges
  - The horizontal vial is tilted for an easy and direct line of sight
  - Gradient lines for slope measurements up to 2%
- Bridge at horizontal vial for increased toughness
- Heavy-duty cast aluminum tapered body
- Shock-absorbing rubber strike pads & end caps withstand trowel blows and protect the level's integrity
- Finely milled surface
- Accuracy: <math><0.5 \text{ mm/m (0.0005 in/in.)}</math>



## 920 SHARK® The Ultimate Mason's Level



- 2 solid acrylic vials, including:
  - Plumb Site® Dual-View™ vial
  - Epoxy-locked horizontal vial
- Milled surface
- Heavy-duty cast aluminum tapered (trapezoid) body

- Shock absorbing rubber "anvils"
- Accuracy: <math><0.5\text{ mm/m}</math> (0.0005 in/in.)

**Optional**

- Magnetic model: 920M

Inch	16	20	24	32	40
Centimeter	40	50	60	80	100
	320g	390g	470g	630g	770g

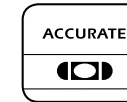
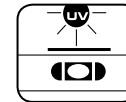

0.5mm/m (0.0005in/in.)

## 720 SUPERCAST™



- 2 solid acrylic vials
- Milled surface
- Heavy-duty cast aluminum tapered (trapezoid) body
- Accuracy: <math><0.5\text{ mm/m}</math> (0.0005 in/in.)

**Optional**

- Magnetic model: 723
- Adjustable horizontal vial on 30cm (12") and 80cm (32") lengths

Inch	12	16	20	24	32
Centimeter	30	40	50	60	80
	320g	370g	440g	510g	640g

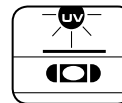

0.5mm/m (0.0005in/in.)



## 730 TOPCAST™ The Toughest Cast Level at the Very Best Price



Inch	24	32
Centimeter	60	80
	750g	890g

- 2 Solid acrylic vial
- 2 heavy-duty cast aluminum “anvil” strike pads for trowel blows during tile work
- Drill bit diameter gauge in the level’s profile
- Milled surface
- Accuracy: <0.5 mm/m (0.0005 in/in.)

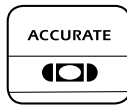
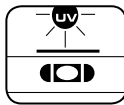

0.5mm/m (0.0005in/in.)

## 820 SUPERCAST™



Inch	24	32
Centimeter	60	80
	790g	990g

- 3 solid acrylic vials
- Adjustable horizontal vial
- 2 milled surfaces
- Heavy-duty cast aluminum body
- Accuracy: <0.5 mm/m (0.0005 in/in.)

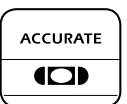
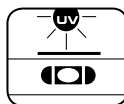

0.5mm/m (0.0005in/in.)

## 935 OPTIVISION™ RED ToolBox Level 25cm (10")

2.2" (5.5cm)



- 3 unbreakable acrylic shockproof vials, including:
  - OPTIVISION™ Red horizontal vial creates highly visible red bubble edges
  - Tilted horizontal vial with epoxy locking for direct line of sight viewing
  - Vial gradient lines for measuring slopes up to 2%
- Accuracy: <math><0.5\text{ mm/m}</math> (0.0005 in/in.)

- Angle transfer vial with gradient marking every 5°
- Rare-Earth magnets for the strongest grip to any metal surface
- Finely milled surface with V-groove
- Advanced impact resistance end caps to protect the level's integrity

### Optional

Fixed third vial at 45°

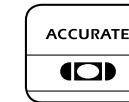
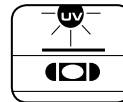

0.5mm/m (0.0005in/in.)



## 923 CAST TOOLBOX LEVEL 25cm (10")

4.5cm (1.8")



- 3 solid acrylic vials, including:
  - 1 Plumb Site® Dual-View™ vial
  - Epoxy-locked horizontal vial
  - 45° angle vial
- Heavy-duty cast aluminum body

- Milled surface with Rare-earth magnets
- V-groove for easy placement on pipes/conduit
- Accuracy: <math><0.5\text{ mm/m}</math> (0.0005 in/in.)

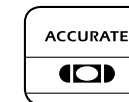
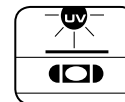

0.5mm/m (0.0005in/in.)





## 946 Smarty Magnetic cast aluminum level 10cm (4")



- OPTIVISION™ Red horizontal vial - in solid acrylic - creates highly visible RED bubble edges
- Gradient lines for measurements 1% & 2%
- Durable cast aluminum body with shockproof rubber
- Large base with Rare-earth magnets
- Clip belt housing
- Precision: 0.5mm/m (0.0005 in/in.)

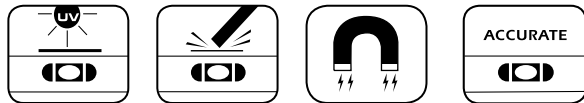

0.5mm/m (0.0005in/in.)



## 846 CYCLOPS The Magnetic Pocket Cast Level



- One Plumb Site® Dual View™ vial for vertical & horizontal reading
- Two finely milled magnetic surfaces with V-grooves
- Durable cast aluminum body
- Accuracy: <0.5 mm/m (0.0005 in/in.)
- Fits in your pocket

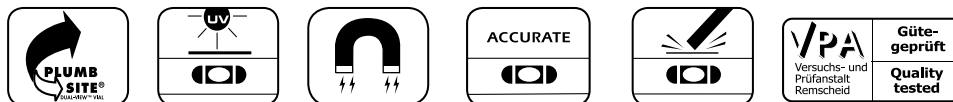

0.5mm/m (0.0005in/in.)





## 724 KAPRO VALUE CAST TOOLBOX LEVEL 25cm (10")



- 2 solid acrylic shockproof vials – horizontal and vertical
- Cast aluminum body
- Milled surface
- Accuracy: <math><0.5 \text{ mm/m}</math> (0.0005 in/in.)
- Available in 12 piece display

**Optional:**

- Magnetic model 724M

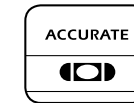
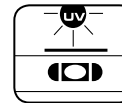

0.5mm/m (0.0005in/in.)



## 929 TOOLBOX LEVEL 25cm (10")



- 3 easy-to-read vials (horizontal, vertical, 45°), including 1 Plumb Site® Dual-View™ vial
- Leveling ledge for tiles/sills

- Tough internal aluminum frame and base
- Magnetic V-groove for pipe/conduit
- Available in 15 piece display



## 227 TOOLBOX LEVEL 23cm (9")

- 3 easy-to-read vials (horizontal, vertical, 45°)
- Magnetic V-groove for pipe/conduit
- Tough rubber end caps
- Available in 20 piece display



100g

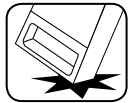

## 229 TOOLBOX LEVEL 23cm (9")

- 3 easy-to-read vials (horizontal, vertical, 45°)
- V-groove for pipe/conduit
- Magnetic base
- Available in 20 piece display



90g



## 246 HANDY LEVEL 10cm (4")



- Shockproof solid acrylic vial
- Lightweight aluminum box profile fits easily into your tool belt or pocket
- Shockproof end caps
- Accuracy: <math><0.5 \text{ mm/m}</math> (0.0005 in/in.)

**Optional**

- Magnetic (246M)
- Available in 10 piece display

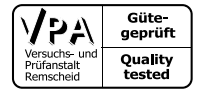
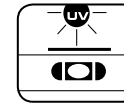

0.5mm/m (0.0005in/in.)

## 350 PIPE LEVEL 5 PIECE SET



- For standard metal and plastic pipe sizes (see table)
- Spring loaded for easy click-on attachment
- 2 easy-to-read vials – vertical and horizontal
- Available in clip strip

Nominal Sizes	IPS Steel	CTS Copper	PP Plastic
	Stainless Steel PVC Plastic Inches/mm	Inches/mm	Inches/mm
1/2"	1/2 15	3/4 20	25
3/4"	3/4 20	1 25	32
1"	1 25	1 1/4-1 1/2 32-40	40
1 1/4" -1 1/2"	1 1/4-1 1/2 32-40	—	50
2"	2 50	—	63

## 340 POSTRITE® Folding Post Level



- 3 vials
- Folds closed, opens flat
- Click-lock every 15°
- Adjustable elastic strap for non-magnetic surfaces
- 4 powerful magnets for metal surfaces
- For all posts, pipes and signs
- Available in 6 piece display

Patented

170g

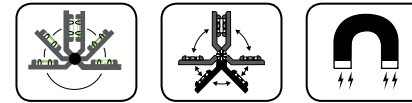

## 341 MINI POST LEVEL The Handy Post Level



- 3 vials
- Adjustable elastic strap for non-magnetic surfaces
- 4 powerful magnets for metal surfaces
- Pre-cast holes for easy mounting with nails
- For use with all posts, pipes and signs
- Available in 12 piece display

100g



# 985D DIGIMAN® Professional Magnetic Digital Level



- Plumb Site® Dual-View™ vial, solid acrylic vials, Ergo Grip™ handles, shockproof end caps
- 45° tilted LCD display with backlight
- 180° readout – display remains straight when the level is upside-down
- Digital accuracy: <math><0.1^\circ</math> at level and plumb, <math><0.2^\circ</math> other angles
- HOLD function for transferring measurements
- MODE function: Degree/percentage/pitch
- Memory recall – 9 measurements
- Buzzer at 0°, 45° and 90°

- Recalibration function and "False Zero"
- Rainproof & dust resistant
- Large silicon buttons which are easy to use while wearing gloves
- Two finely milled surfaces with rare earth magnets 60cm (24"), 120cm (48")

**Optional**

- Waterproof bag

Inch	10	24	48
Centimeter	25	60	120

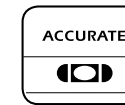
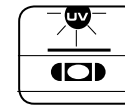

0.5mm/m (0.0005in/in.)



**Also available in 60cm with laser pointer (985D-L)**

- Range: 50m (165')
- Tripod ready - 1/4" thread





## 992 DIGITAL BEVEL 25cm (10")

Precise Angle Measurer and Level



- Adjustable blade locks at any angle for marking and cutting lines
- Designed for use with power hand-saw
- Clear digital display flips for upside-down reading
- Reference angle (false zero) for transferring angle measurements
- Easy recalibration
- Anodized aluminum profile
- Digital accuracy:  $<0.1^\circ$

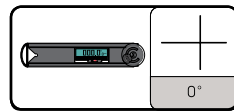
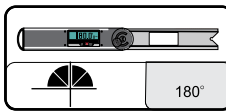
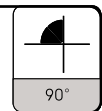
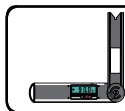
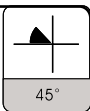
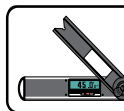

## 925 TOPCLASS MAGNETIC TORPEDO LEVEL 25cm (10")

**NEW**

- CNC Machined level
- Anodized coated with anti-corrosion protection
- Epoxy locked vials x4
- Extra strong rare earth magnets
- Plumb Site vertical vial  
Horizontal vial  
45° vial  
30° vial
- Hanging strap
- Ruler
- Electrical plug markers (71mm)
- V-groove for pipes

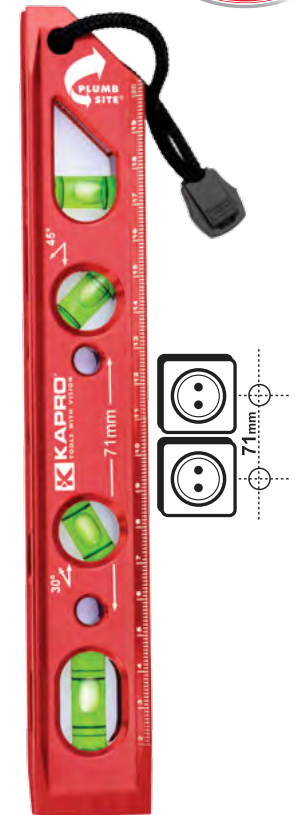

## 103 INCLINOMETER Gradient Level



- 1 solid acrylic vial
- Scale in % and degrees
- Accuracy: <math><0.5 \text{ mm/m}</math> (0.0005 in/in.)



605g/m

**Optional**

- Magnetic model: 103M



13cm (5.1")

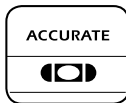
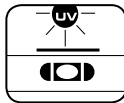

0.5mm/m (0.0005in/in.)

Inch	8	12	16	20	24	32	40	48
Centimeter	20	30	40	50	60	80	100	120

## 104 DRAINAGE LEVEL Gradient Level up to 10%



1.5kg

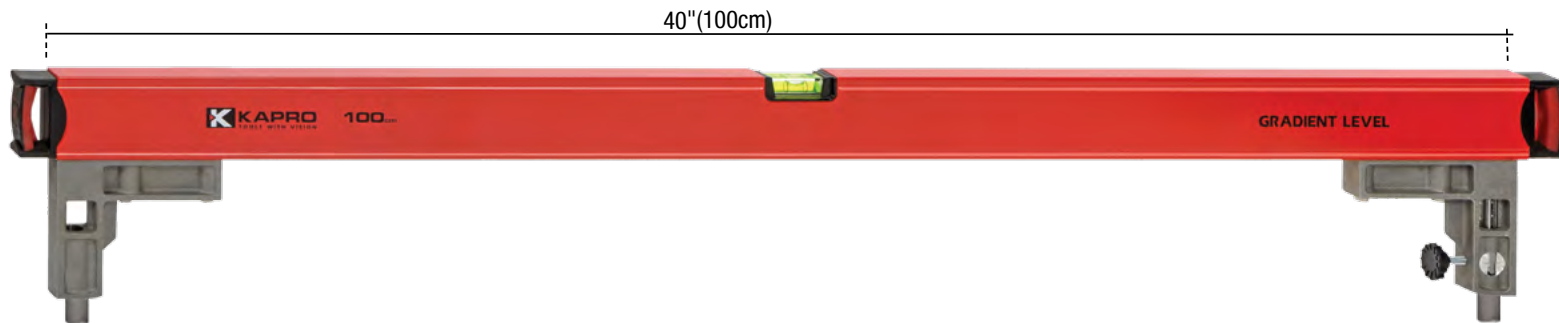

40"(100cm)

16cm (6.3")

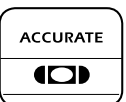

0.5mm/m (0.0005in/in.)

- 1 solid acrylic vial
- Sets measuring slopes up to 10%
- Exact length (40"/100cm) for easy use
- Accuracy: <math><0.5 \text{ mm/m}</math> (0.0005 in/in.)

## 105 TOPGRADE™ Gradient Level up to 2%

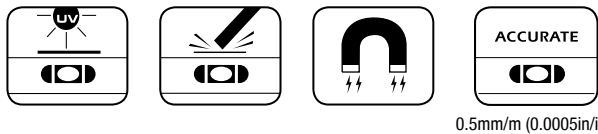
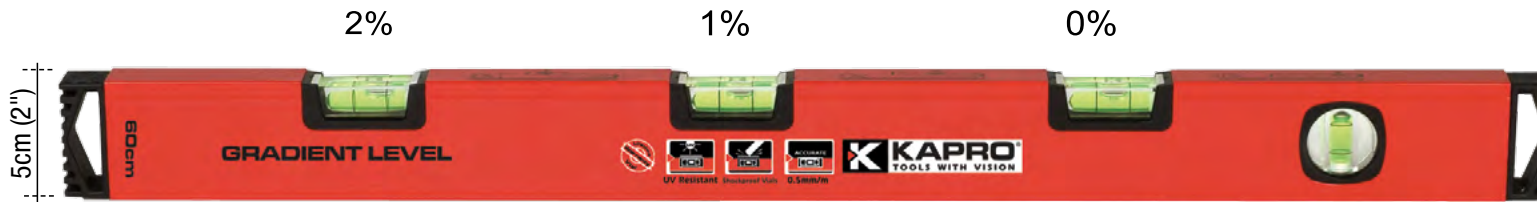

- Solid acrylic horizontal vials (3 to 5 vials depending on the length of the level) + 1 vertical vial
- Accurate slope measurement up to 2%

- Accuracy: <math><0.5\text{ mm/m}</math> (0.0005in/in.) on all vials
- Milled surface

**Optional**

- Magnetic model: 105M

Inch	24	40	48
Centimeter	60	100	120
	3+1 vials	5+1 vials	5+1 vials

## 783 ELECTRICIAN'S LEVEL Position Power Sockets Perfectly

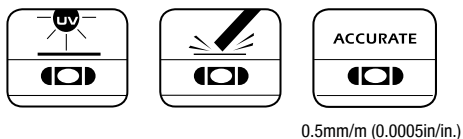

- 4 markers set at 71mm intervals for exact spacing of power sockets
- 2 solid acrylic shockproof vials, vertical & horizontal
- Tough aluminum box level profile

- Shock-absorbing end caps
- Accuracy: <math><0.5\text{ mm/m}</math> (0.0005 in/in.)
- 120cm model includes: electrical socket and switch height from the floor and countertop and phone outlet spacing from sockets

Available in cm 43 | 120



108 BOX LEVEL 70cm Plumbing Installation Level

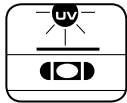
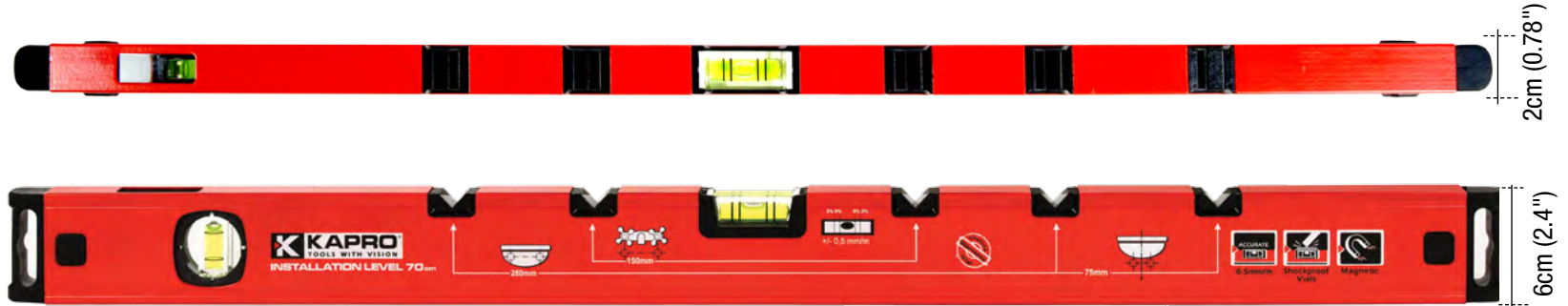

0.5mm/m (0.0005in/in.)

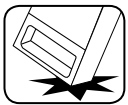

- 2 epoxy locked solid acrylic vials:
  - 1 vertical vial with Plumb Site Dual View
  - 1 horizontal vial with gradient lines up to 2%
- 5 markers designed into the level's profile at standard sink installation points:
  - 280mm for sink attachment to wall
  - 150mm for faucet placement
  - 75mm for water pipes below the sink

- Accuracy 0.5mm/m (0.0005in/in.)
- Shock absorbing rubber end caps
- Wall grip feature keeps the level in place on a vertical surfaces
- Reinforced aluminum box profile
- Optional**
- Magnetic model: 108M

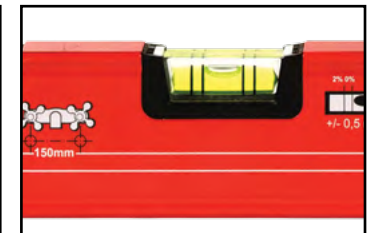
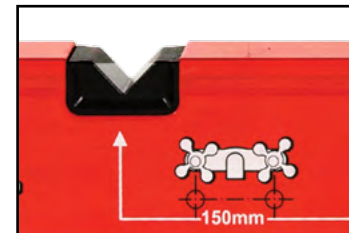

# SCREEDS

## Standard ruler lengths

Inch	40	60	70	80	96	10'	11.5'	13'
Centimeter	100	150	180	200	250	300	350	400

Tested for straightness

## Model 152

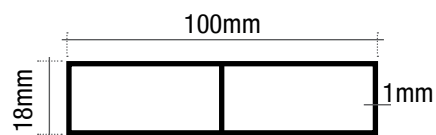

## Model 154

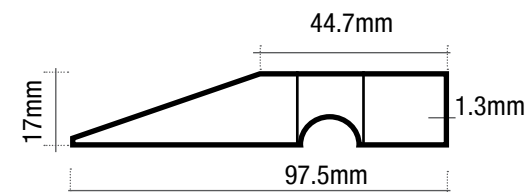

## Model 153

153-31: 2 solid acrylic vials  
153-32: 2 vials with handles

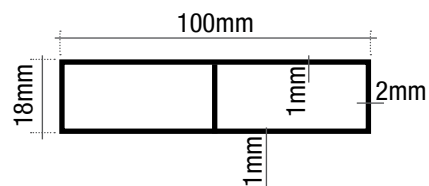

## Model 155

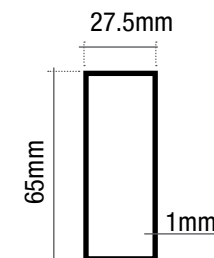

## 245 MINI LEVEL

- 2 easy-to-read vials
- Angle finder with patented Top-Scroll adjustment
- Pocket size
- Strong molded plastic casing



## 440/441 LINE LEVELS

- Especially lightweight to prevent line sag
  - V-groove for pipe work (440)
  - Handy pocket clip (440)
  - Aluminum base (441)
- Optional**
- Available as a set with 20m (65') cord (440)



## 240/242 SURFACE LEVELS

- Multipurpose levels
- Pre-cast holes for easy attachment
- Sensitivity: 30arc/min.



240 Bull's Eye Level



242 Magnetic Cross Level









# 875 PROLASER® ALL LINES

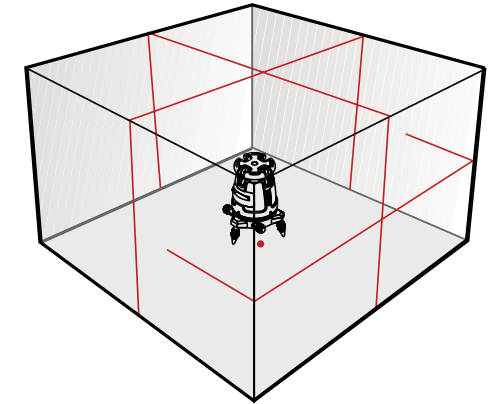

- Generates five laser lines (1 horizontal and 4 vertical) with intersection on the ceiling and one plumb dot
- Laser Range:
  - Indoor range : up to 20m (65')
  - Outdoor range (with detector): up to 40m (130')
- Accuracy : 0.2mm/m (0.05"/20')
- Self-leveling range of  $\pm 2.5^\circ$
- Visual and audible warning for "out of level" position
- Manual mode for tilted marking
- Tripod ready (5/8")
- Rechargeable lithium battery
- USB connection for charging the lithium battery

### Applications

- Setting floor and wall tiles
- Hanging acoustic ceilings
- Framing and aligning windows and doors
- Leveling electrical outlets, plumbing and studs
- Drywall installation and deck construction

### Includes

Beamfinder™ glasses, laser target, soft carry case, Rechargeable lithium battery

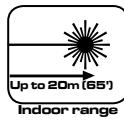

# 875S PROLASER® ALL LINES SET

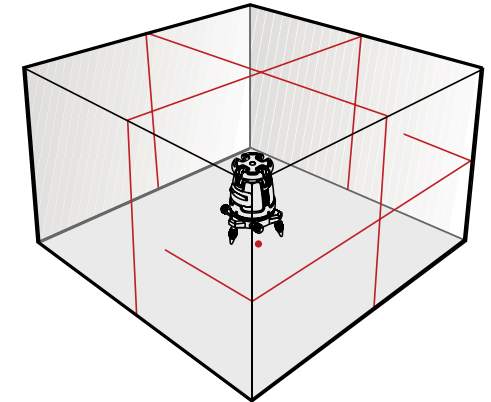

- Generates five laser lines (1 horizontal and 4 vertical) with intersection on the ceiling and one plumb dot
- Laser Range:
  - Indoor range : up to 20m (65')
  - Outdoor range (with detector): up to 40m (130')
- Accuracy : 0.2mm/m (0.05"/20")
- Self-leveling range of  $\pm 2.5^\circ$
- Visual and audible warning for "out of level" position
- Manual mode for tilted marking
- Tripod ready (5/8")
- Rechargeable lithium battery
- USB connection for charging the lithium battery

## Applications

- Setting floor and wall tiles
- Hanging acoustic ceilings
- Framing and aligning windows and doors
- Leveling electrical outlets, plumbing and studs
- Drywall installation and deck construction

## Includes

Beamfinder™ glasses, laser target, tripod & tripod adaptor hard carry case (875S), Rechargeable lithium battery

**Option with detector 894-04 (See p. 56)**

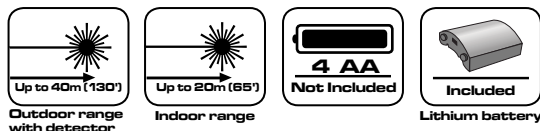

# 883N PROLASER® 3D ALL-LINES 360° beams in every direction - Indoor & Outdoor Use

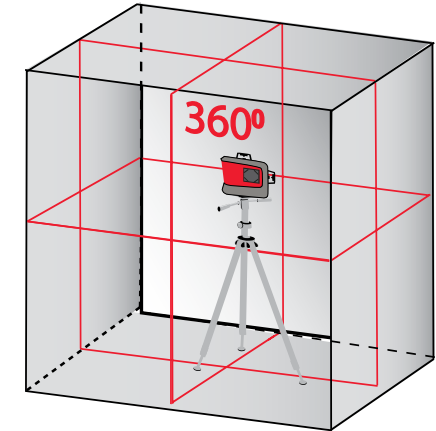

- Horizontal 360°, Side vertical 360°, Forward vertical 360°, Forward vertical 360°+ Side vertical 360°, Horizontal and verticals all 360°
- Automatic Self-leveling
- Manual mode for tilted marking
- Laser Range:
  - Indoor – 20m (65')
  - Outdoor with detector - 60m (200')
- Accuracy:  $\pm 0.2\text{mm/m}$  (0.0002"/")
- Tripod-ready 1/4"

### Applications

- Accurately laying out right angles for flooring, drywall installation and deck construction
- Leveling slopes (manual mode)
- Hanging acoustic ceilings
- Framing and aligning windows and doors

### Includes

Hard carry case, Multi-functional magnetic mount, target

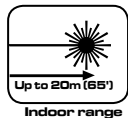

# 873 PROLASER® VECTOR

**NEW**

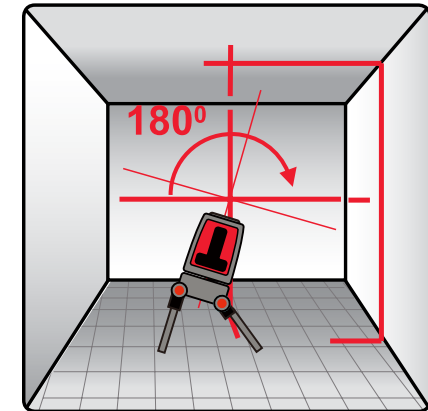

- 1 Horizontal and 2 vertical lines at 90°, intersections - forward and on the ceiling
- Laser Range:
  - Indoor: 30m (100')
  - Outdoor : 50m (165') with detector
- Accuracy: 0.2mm/m (0.0002in/in.)
- Manual mode for angular layout/marketing
- Strong folding legs for angle mounting in manual mode and height adjustment
- Self-leveling range:  $\pm 5^\circ$
- Visual and audible "out of level" warning

- 1/4" tripod thread
- Shock resistant rubber casing
- Compact size – fits in your toolbox

### Applications

- Framing
- Tiling, cabinets, borders, moldings and trims
- Door and window installation
- Electrical socket alignment

### Options

- Available as a laser set with pole & tripod (873S)



3.20 meters (10.5ft) maximum height with 1/4" & 5/8" UNC thread

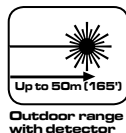

# 872 PROLASER® PLUS - RED

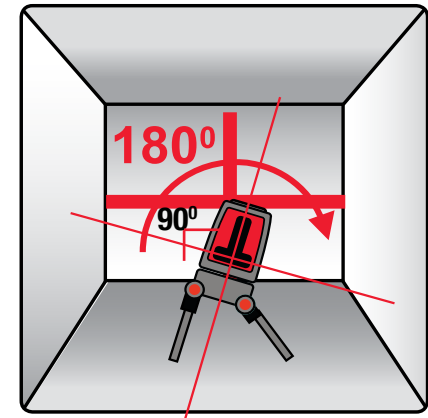

- Intersecting horizontal and vertical lines at 90°
- Laser Range:
  - Indoor: 30m (100')
  - Outdoor: 50m (165') with detector
- Accuracy: 0.2mm/m (0.0002in/in.)
- Manual mode for angular layout/markings
- Strong folding legs for angle mounting and height adjustment
- Self-leveling range:  $\pm 5^\circ$
- Visual and audible "out of level" warning
- 1/4" tripod thread

- Shock resistant rubber casing
- Compact size – fits in your toolbox
- Includes: Pouch & adaptor (841)

### Options

- Laser with Tripod 1.3m (872S)
- Laser with wall mount (872L)
- Available with green beam (872G)

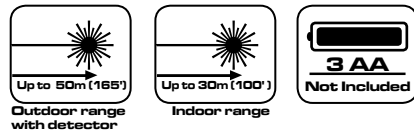



# 872G PROLASER® PLUS - GREEN

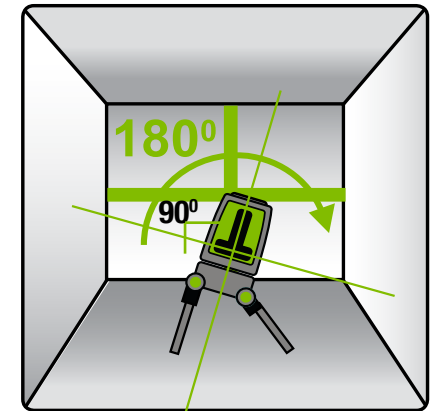
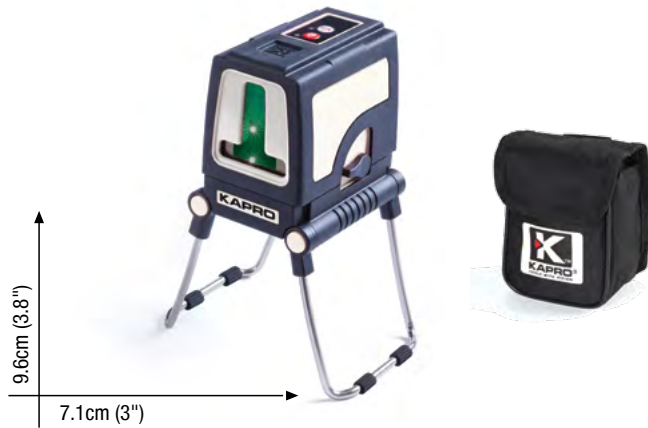

- Intersecting horizontal and vertical lines at 90°
- Laser Range:
  - Indoor: 30m (100')
  - Outdoor: 60m (200') with detector
- Accuracy: 0.2mm/m (0.0002in/in.)
- Manual mode for angular layout/marking
- Strong folding legs for angle mounting and height adjustment
- Self-leveling range:  $\pm 5^\circ$

- Visual and audible "out of level" warning
- 1/4" tripod thread
- Shock resistant rubber casing
- Compact size – fits in your toolbox
- Includes: Pouch & adaptor (841)

**Option**

- Laser with Tripod 1.3m (872GS)

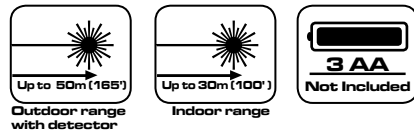

## 841 TRIPOD ADAPTOR

- Converts tripod thread from 1/4" UNC to 5/8" UNC
- Compatible with ProLaser® Plus 872 & 873 ProLaser® Vector





# 862 CROSS LINE LASER

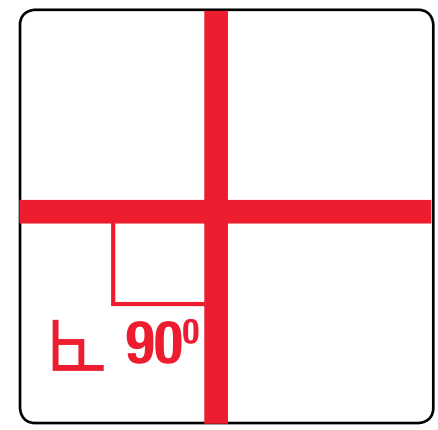

- Vertical, horizontal and cross beams
- Range: 20m (65') indoor
- Accuracy:  $\pm 0.3\text{mm/m}$  (0.0003in/in.)
- 1/4" tripod thread
- Self-leveling range:  $\pm 5^\circ$
- Manual mode for angular layout/markings
- Visual and audible "out of level" warning

**Applications**

- Tiling
- Laying cabinet
- Decoration work

**Includes**

Soft carry case & velcro strip

**Option:**

862 with tripod 1.3m (862S)



1. Magnets x2
2. Hanging hole
3. V-Groove
4. "Velcro" strip

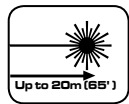

# 896 PROLASER® 5-DOT Self-Leveling Laser Pointer

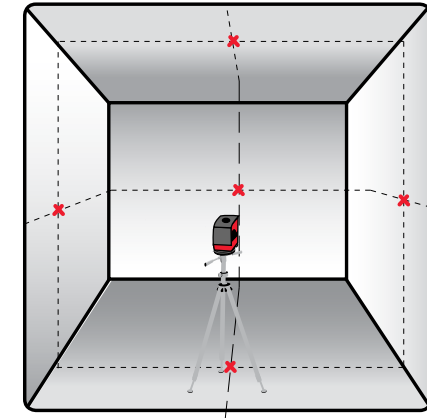

- Five highly visible laser dots: Plumb up & down, 3 level dots at 90° angles
- Laser Range: 30m (100') with target
- Accuracy – Level: 0.4mm/m, Plumb up: 0.5mm/m, Plumb down: 0.75mm/m
- Small cross projected at each laser dot
- Quick & easy one-button operation
- Self-leveling range:  $\pm 4^\circ$
- Tripod-ready
- Tough rubber overlay
- Visual out of leveling range flashing beams

### Applications

- Wall stud layout and partition installation
- Electrical outlet and switch layout
- Framing rooms, doors and windows
- Finishing carpentry
- Transferring points
- Vertical and horizontal alignments

### Includes

Magnetic multi-functional base, laser target, soft carry case

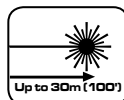

VIEW VIDEO

# 899 PROLASER® SELF-LEVELING ROTA-LINE



- 360° rotating beam in horizontal or vertical planes, plumb up and plumb down points
- Laser Range:
  - Indoor: 50m (165'),
  - Outdoor: 250m (820') radius with detector
- Accuracy: 0.1mm/m (0.0001in/in.)
  - Electronic self-leveling on slopes of  $\pm 5^\circ$
- Manual mode for marking slopes up to  $\pm 5^\circ$  in both X and Y planes
- Five variable speeds (0, 60, 120, 300, 600 rpm)
- Six scan modes create  $< 360^\circ$  visible laser line
- Tripod-ready 5/8"

### Applications

- Laying foundations
- Wall, fence and deck construction
- Laying water and sewerage lines
- Indoor layouts

### Includes

Remote control, laser detector, shockproof carry case, BeamFinder™ glasses  
 Supplied with internal batteries and battery charger - AC/DC convertor



VIEW VIDEO

## 891 LASER SQUARE for Tiling



- Projects 2 highly visible lines at 90° across the floor and up the walls
- Laser Range: up to 30m (100') with target
- Accuracy: 0.5mm/m (0.0005 in/in.)
- ABS unit with aluminum base for improved flatness

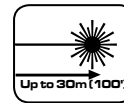
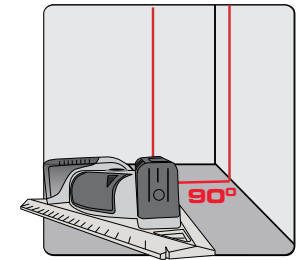

VIEW VIDEO

## 389 MULTISCANNER STUD SENSOR Electronic Cable, Metal & Stud Sensor

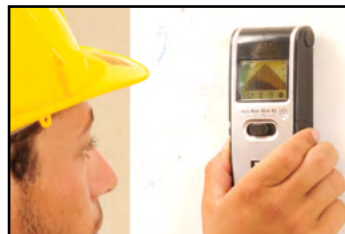

- Electronic sensors detect live AC wires, metal, studs & wood
- Detection buzzer
- Easy to read backlit screen
- Automatic scan
- Maximum Scanning Depth
  - Metals: 75mm
  - Live AC Wires: 75mm
  - Copper pipes: 30mm
  - Metal Pipes: 38mm
  - Wood: 18mm



VIEW VIDEO

## 375 KAPROMETER K5 with Beamfinder™ Flip Cover



3cm (1.18")  
12cm (4.7") x 5.5cm (2.1")

More Accurate View at a Distance

- Indoor measuring distance of up to 70m (230')
- Beamfinder™ flip cover helps you to clearly locate the laser dot on the intended target surface and protect the keypad
- Measures the shortest distance to target with Dynamic (continuous) measuring
- Measures area and volume
- Accuracy: 1.5mm
- Indirect measuring using Pythagoras (single & double)
- Choice of 3 reference points
- Advanced memory function
- Impact-resistant rubber over-mold
- Tripod-ready 1/4" thread



## 383 KAPROMETER K1 Laser Distance Measurer



- Measures area, distance and volume
- Indirect measuring using Pythagorean theorem
- Measuring Range: 30m (100')
- 2 measuring reference points
- Memory function
- LCD display
- Accuracy: ±2mm

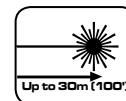



# 377 KAPROMETER K7 with Bluetooth



**Bluetooth**

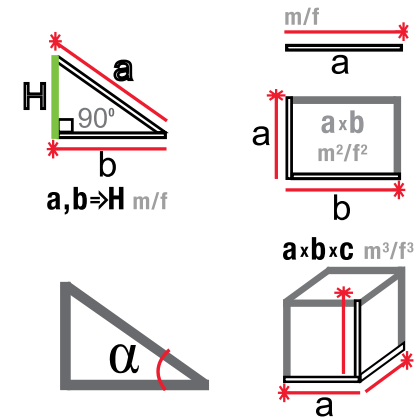

- Measuring distance of up to 100m (330')
- Beamfinder™ flip cover helps you to clearly locate the laser dot on the intended target surface and protect the keypad
- Measures the shortest distance to target with Dynamic (continuous) measuring
- Measures area and volume
- Indirect measuring using Pythagoras (single & double)
- Choice of 3 reference points
- Accuracy: 1.5mm
- Advanced memory function
- Impact-resistant rubber over-mold
- Tripod-ready 1/4" thread
- Bluetooth communication and friendly free application
- Integrated angle meter

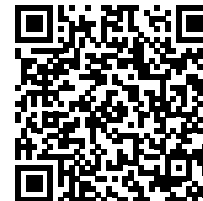
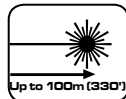

GET IT ON  
Google play



Download on the  
App Store



## 893 T-LASER™ Clip-on Marking Laser

Patented

- 90° Highly visible laser line
- Spring grip slides onto edge of standard boards 1/4"-5/8" (6.4mm-15.9mm)
- Pressure-activated power switch
- Manual on/off switch for use as surface laser
- Bi-material molded case with rubber overlay

- Handy belt clip
- Laser Range: 3m (10')

### Applications

- Projects a 90° laser line for free-form cutting
- For drywall, composition board, and plywood

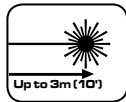
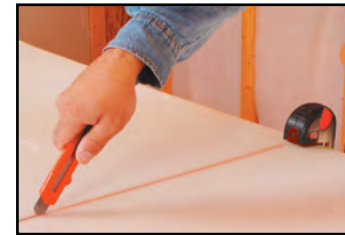

## 810 PROLASER® NAIL GRIPPER™ Line Laser with Nail and Screw Grip

Patented

- Highly visible line laser
- 2 easy-to-read vials
- Patented rubber grip holds any size nail/screw
- Pressure-activated on/off
- Magnetic wristband included for holding nails and screws
- Laser Range: 6m (20')

### Applications

- Hanging shelves, pictures, and mirrors
- Aligning panels, tiles, and wall coverings



# 814 PROLASER® SET-A-SHELF™ Set & Match® with Laser Line

Patented

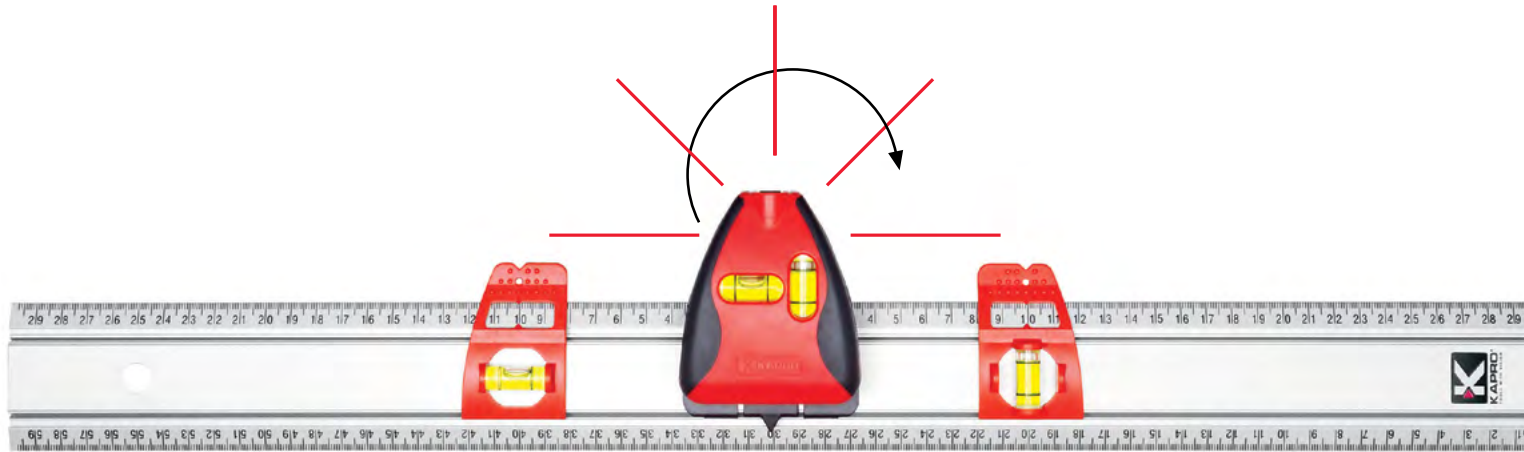

- Horizontal, vertical or 45° lines
- 2 easy-to-read vials
- "Click-in-place" lock
- "Slide & Lock" level markers
- Laser Range: 6m (20')

- Hanging shelves, pictures and cabinets
- Aligning tiles, decorative layouts and patterns

## Applications

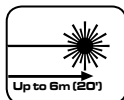

## 886-48/38

Tripod for Laser Level

- Professional tripod –up to 2.32 meters, with scale and vial (886-48)
- Lightweight tripod –up to 1.20 meters, with vial (886-38)



886-48



886-38

## 886-58

Pole with Tripod

- Telescoping pole with locking sections
- 3.2 meters (10.5') maximum height
- Strong lightweight tripod stand with surface level
- Adjustable laser mount with 5/8" UNC thread

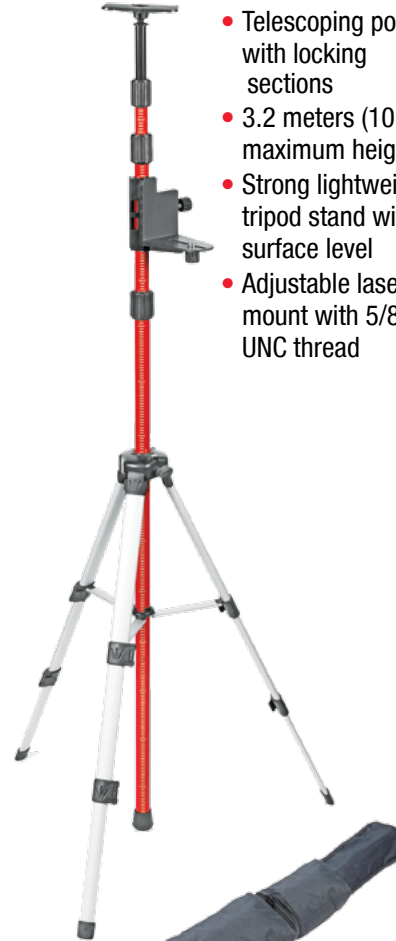

## 886-30

Extendable Pole for Laser Level

- Self-clamping between floor and ceiling
- 3 meters (10ft) maximum height
- Includes adjustable laser mount with 5/8" UNC thread



## 886-10

### Leveling Disk for Laser Level

- Attachment fits standard tripod
- Locking screw to secure laser level at required angle
- Rotary scale in degrees
- Standard 5/8" UNC (16mm) thread for attachment to tripod



## 886-20

### Laser angle mount

Accurate indication of inclined angle



## 845

### Laser Target

- Magnetic
- Special reflective surface
- Graduated target (in/cm)



## 840

### Beamfinder™ Glasses

Enhances visibility of laser beam



## 894-04

### Laser Detector for Red beams only

For use with Pulse enabled laser tools for extended ranges



## 886-23

### Universal Wall mount

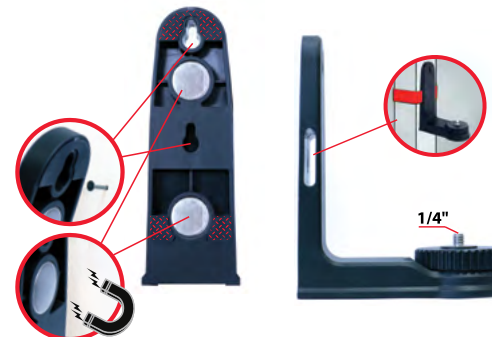



**LAYOUT,  
MARKING & MEASURING**

**Cutting-Edge Designs**



# LAYOUT & MARKING





## 211 PLUMB BOB CHALK LINE Classic design



- Durable Easy Grip™ case
- All-in-one end hook: holds on nails & ledges, tacks into drywall
- Break-resistant & powder absorbent chalk line string
- Clean chalk refill – won't spill
- Wall mount & storage hanger
- 3 oz (85g) capacity & 30m (100') line

## 211S PLUMB BOB CHALK LINE WITH CHALK

A set with 4 oz (113g) red or blue chalk bottle



## 213 ERGONOMIC CHALK LINE Rubber "nose" holds line taut

Patented



- Break-resistant & powder absorbent chalk line string
- Ergonomic handle
- Rubber nose – holds line for perfect string tension
- All-in-one end hook: holds on nails & ledges, tacks into drywall
- Clean chalk refill – won't spill
- Wall mount & storage hanger
- 3 oz (85g) capacity & 30m (100') line

### Optional

Available as a set with 4 oz (113g) red or blue chalk bottle



## 214 SURE GRIP CHALK LINE & LEVEL Integrated line level & extra-fast rewind

Patented



- "Sure Grip" ergonomic handle & shockproof bi-material case
- Retractable line level clicks into chalk line
- **6X faster** rewind with string lock mechanism
- All-in-one end hook: holds on nails & ledges, tacks into drywall
- Break-resistant & powder absorbent chalk line string
- Clean chalk refill – won't spill
- Wall mount & storage hanger
- 4 oz (113g) capacity & 30m (100') line



## 201 ZINC CHALK LINE Plumb bob design



- Heavy-duty zinc body
- Doubles as a plumb bob
- 3 oz (85g) capacity
- 100' (30m) highly absorbent polyester line



## 222 CHALK BOTTLES Available with blue and red chalk



Available in 4 bottle volumes:

4 oz (113g)

8 oz (226g)

2.5 lb (1kg)

5 lb (2kg)

## 325 MAGNETIC LOCK COMBINATION SQUARE

Patented



- Magnetic lock adjustment
- Stainless steel blade
- Permanently etched ruler markings (inches and centimeters)
- Heavy-duty cast zinc body
- 5 milled sides for superior accuracy
- Easy Grip™ magnet-held stainless steel scribe
- Belt holster included
- Ruler available in 15cm (6"), 30cm (12") and 40cm (16") lengths
- Easy to read vial

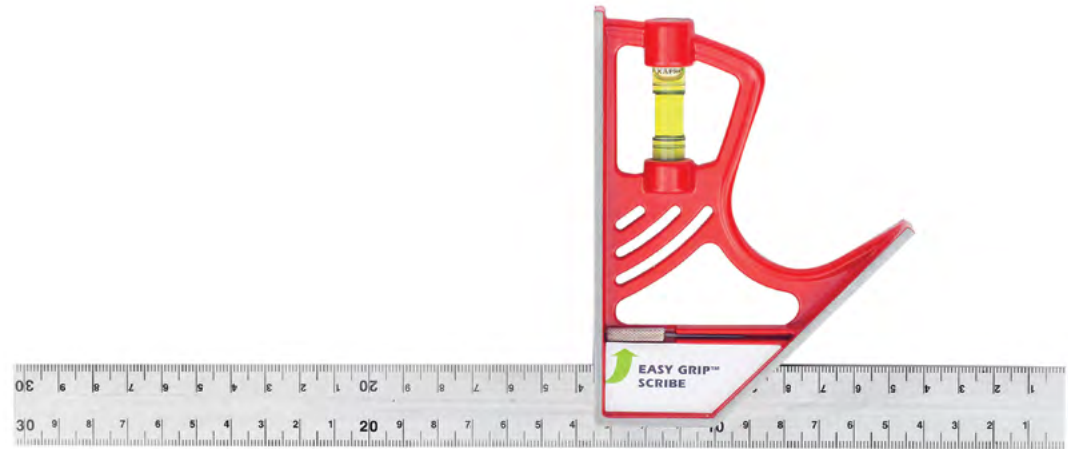

## 352 COMBINATION SQUARE

- Heavy-duty cast zinc body
- Milled on all sides
- Stainless steel blade
- Permanently etched ruler markings (inches and centimeters)
- Ruler available in 30cm (12") and 40cm (16") lengths
- Easy to read vial

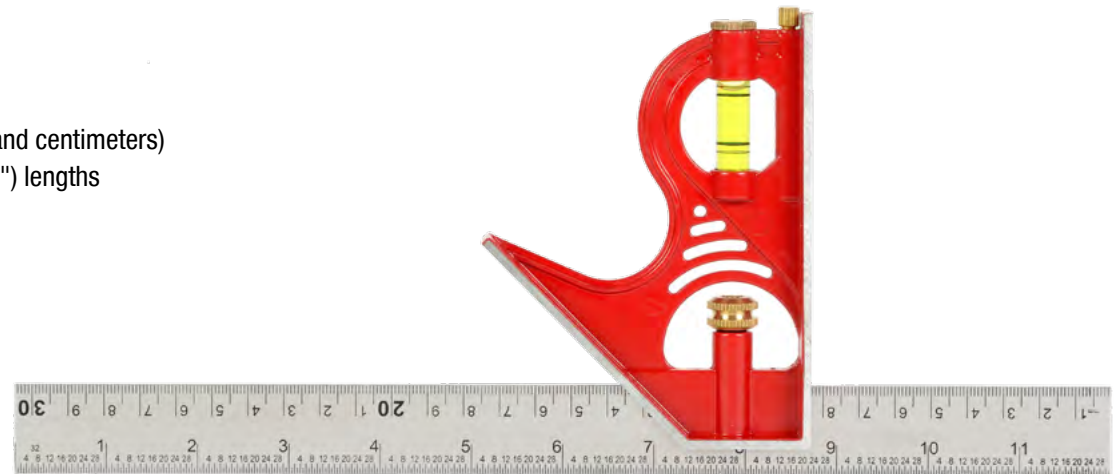

## 309 LEDGEND™ SQUARE

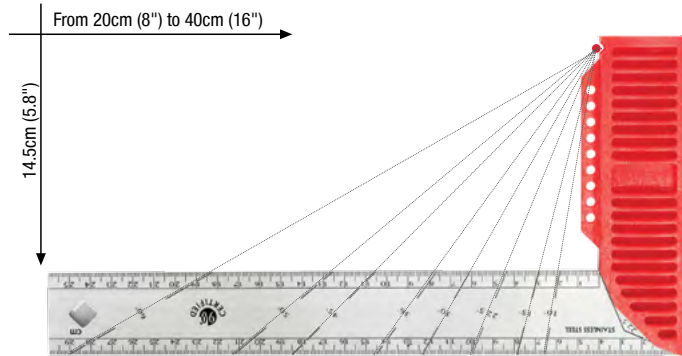

- Unique support ledge
- High-impact polymer handle
- Permanently etched stainless steel blade
- 22.5°, 45°, 67.5° and 90° angles for beveling and framing
- Inch/cm gradations
- Certified 90°
- Marking point

Patented

Inch	8	10	12	16
Centimeter	20	25	30	40

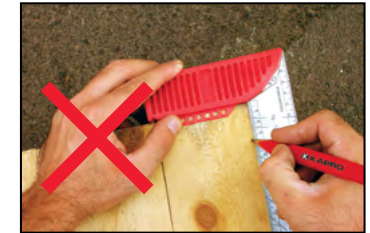

## 307 TRY & MITRE SQUARE

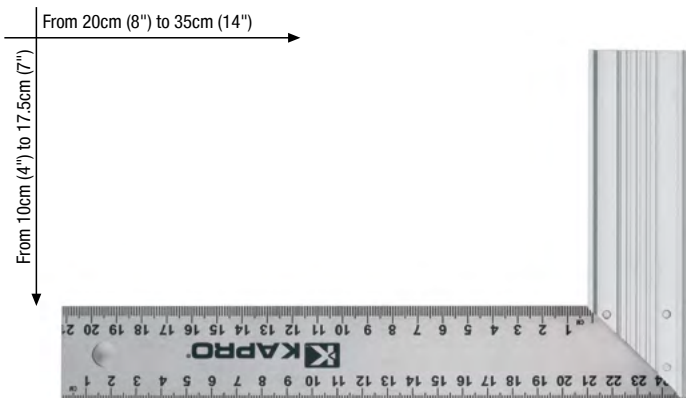

- Solid riveted construction
- Stainless steel non-corrosive tempered blade
- Permanently etched long life gradations
- Certified 90°

Inch	8	10	12	14
Centimeter	20	25	30	35



## 444 RAFTER SQUARE 7"

- Durable & lightweight Ergocast™ material
- Molded-in conversion tables
- Easy-to-read gradations
- Base enables easy marking and cutting



## 305 FRAMING SQUARE

- Heavy duty painted steel frame
- Durable high visibility printing for all work conditions
- Complete conversion and rafter tables printed on reverse side



## 302 STAIR GAUGE

- Solid brass construction
- For use with framing square
- For stair layout and any other repeat marking





## 301 T-BEVEL



- Easy-to-read vial
- Built-in 5mm ( 3/16") trim gauge on side and bottom
- Angle markings on handle
- Etched stainless steel blade and bolt
- Inch/cm gradations
- Tough rubber handle inserts



## 303 CERAMIC HOLE MARKER



- Fits all standard tile dimensions
- Two hole sizes (75mm, 32mm) for electrical outlets and pipes
- Half-hole for taking measurements after faucet installation
- Fiberglass-reinforced polymer handle with easy-to-read vial
- Angle markings on handle – every 15° & strong screw lock
- Durable PVC sliding ruler (inch/cm gradations)
- 90° wing for perfect accuracy, designed for work with spacers



## 318 ELECTRICAL OUTLET MARKER

- Two easily adjustable, interlocking squares
- Two vials for easy level and plumb alignment
- Vial Accuracy:  $\pm 1$  mm/m
- ABS
- Measuring and marking for electrical socket installation



## 630 TELESCOPIC ALUMINUM RULER

- Height reading at eye level
- Easy to store
- Solid construction maintains accuracy



Feet	10	12
Meter	3	4

## 316 DRYWALL T-SQUARE

- Anodized aluminum finish
- Double edge and angular marking
- Certified 90°
- For marking and cutting all types of drywall/wood
- Angler markings 15°, 20°, 22.5°, 30°, 45°, 60°, 70°, 75°, 80°
- Available in 90cm (36"), 120cm (48") lengths

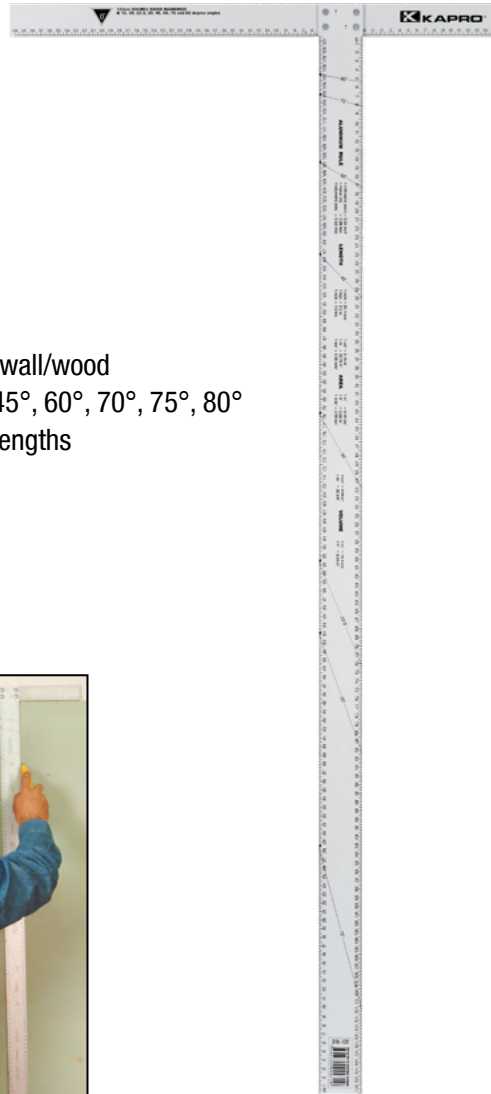
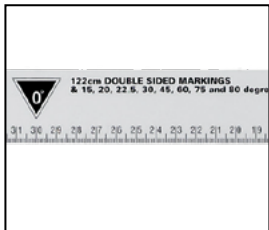

## 317 ADJUSTABLE T-SQUARE

- Anodized aluminum finish
- Sliding head adjusts to any angle
- Folds for easy storage
- ABS end caps with ledge: hands free hold, won't flip
- Double edge, heavy-duty blade
- Durable printed scale and etched angle markings
- Strong screw lock
- 120cm (48") length

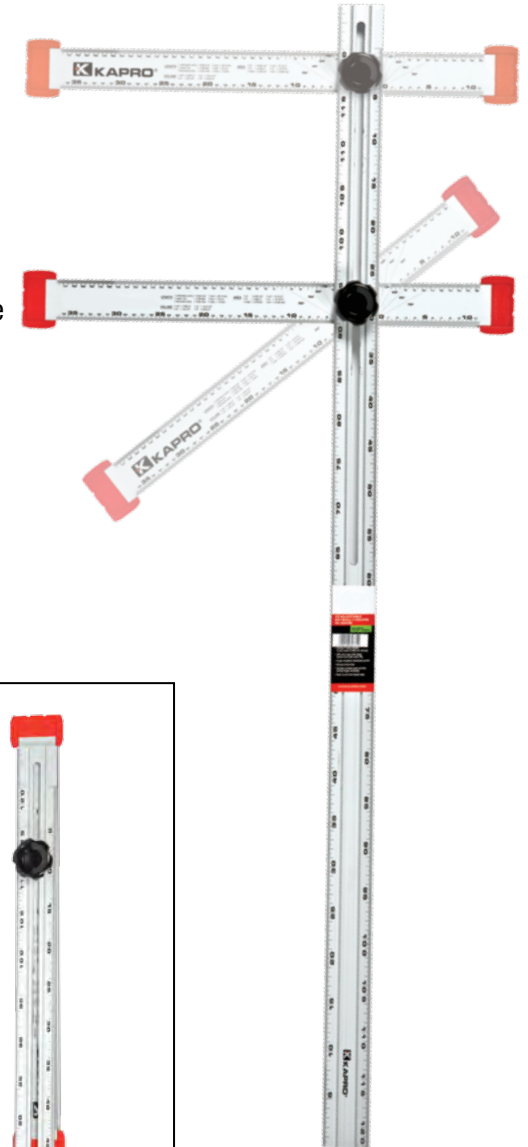
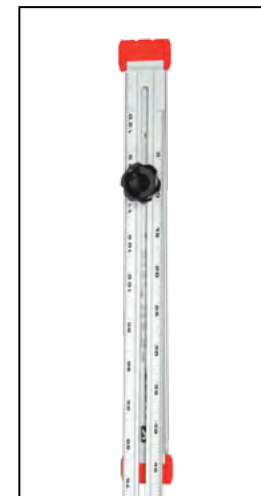

# 314 SET & MATCH® SYSTEM The ultimate layout and marking tool

Patented



**Custom-build your own layout and marking tool – in seconds – with the Set & Match® System. Just “slide and lock” your choice of accessories to the patented Set & Match® Ruler, for the perfect drywall, carpentry or multi-purpose laser tool.**

- Patented Set & Match® Ruler
- 2 easy-to-read slide & lock vials -horizontal and vertical
- Non-slip foam backing

### Applications

- Setting and aligning shelves, cabinets, mirrors, stencils & wallpaper
- Marking/cutting longer lines on walls, wood, drywall, cardboard
- Marking/cutting angled lines



### Handle & Sliding Knife Guide (314-89)

Auto-lock for a sure grip & spring-loaded sliding. Knife guides: slide along the ruler - lock in place. Doubles as a pencil guide. Prevents accidents.



### T-Square (314-90)

Turn your Set & Match® Ruler into a T-Square – with built-in storage and magnetic bar for holding nails & screws.



### Laser line with stud finder

Click-locks at 90° and 45°. Finds concealed metal studs in drywall (See Prolaser® Set-a-Shelf™ p.48)

Inch	20	24	30	32	40	48
Centimeter	50	60	75	80	100	120

# 313 MEASURE MATE The Ultimate Home-Improvement Tool



**Level**  
Sturdy triangular profile + 2 easy-to-read vials



**Align**  
Sliding markers: set & transfer measurements



**Place**  
Electrical & plumbing scale for power sockets & faucets



**Cut**  
Sliding knife guide: safe & accurate



**Center**  
Zero & center point scales

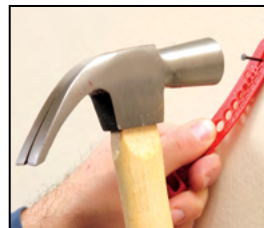

**Grip**  
Nail gripper and drill bit diameter gauge: safe and easy nailing

Inch	12	24	32	40	48
Centimeter	30	60	80	100	120



Available in 15 piece cardboard display



# RULERS

## 306 RULER

- Anodized aluminum ruler
- Durable printing
- Wear-resistant UV cured screen printing
- Printed scale accurate to 0.7mm/m
- 3cm (1.2") width

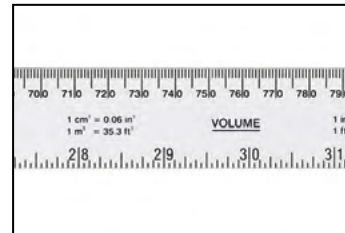

## 308 STRAIGHT EDGE

- Contractor grade
- Anodized aluminum
- Wear-resistant UV cured screen printing
- Printed scale accurate to 0.7mm/m
- 5cm (2") width

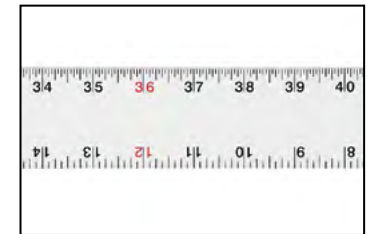

## 312 CUTTING EDGE

- Cutting Edge with handle
- Wear-resistant UV cured screen printing
- Printed scale accurate to 0.7mm/m
- 6cm (2.4") width

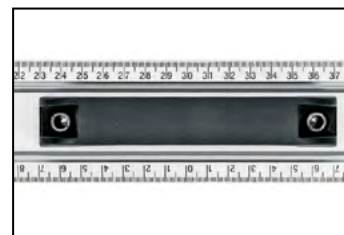

### Standard ruler lengths

Inch	8	12	16	20	24	32	40	48
Centimeter	20	30	40	50	60	80	100	120



## 608 FRAMING TAPE MEASURE



Patented

- Easily centers on corners for accurate diagonal measurements
- Excellent blade extension
- Convenient belt clip
- Pro Touch™ heavy-duty rubber casing

5m	8m
----	----

## 500 STEEL POWER TAPE



- Spring loaded blade return
- One-touch lock mechanism
- Available in inch or centimeter gradations

3m	5m	8m
----	----	----

## 275S CARPENTER'S SHARPENER & PENCILS SET

- For all carpenter's pencils
- Available carded with pencil set
- Top quality
- Pencils won't crumble during sharpening



## 275 CARPENTER'S SHARPENER

- For all carpenter's pencils
- Available carded with pencil set
- Top quality
- Pencils won't crumble during sharpening



## 206 FOLDING RULER

- Unbreakable solid beech wood sections
- Multilayer surface treatment
- Milled ends on scale sections
- Lubricated steel locks & brass fittings
- Centimeter gradations
- Lengths: 1m, 2m



## 660 OPEN REEL TAPES

- Open style for easy wash down
- Heavy duty ABS case
- Marking spike
- Stainless steel end-claw for distance anchoring
- Zero at end of hook
- Lengths: 30m, 50m



## 601 MEASURING WHEELS

- Lightweight and durable telescopic handle
- Metric or imperial reading available
- Wheel diameters: 10cm (4"), 30cm (12")





# **MERCHANDISING & PROMOTIONS**

**Stand Out from the Crowd**







**COUNTER DISPLAYS**



**810 Prolaser® Nail Gripper™**  
6 piece cardboard display

Dimensions:  
11.4" (w) x 9.45" (d) x 11" (h)  
29cm (w) x 24cm (d) x 28cm (h)



**862 Cross Line Laser**  
4 piece cardboard display

Dimensions:  
6.1" (w) x 12.2" (d) x 8.8" (h)  
15.5cm (w) x 31cm (d) x 22.5cm (h)



**227 Toolbox Level 9" (23cm)**  
20 piece cardboard display

Dimensions:  
11.4" (w) x 9.45" (d) x 11" (h)  
29cm (w) x 24cm (d) x 28cm (h)



**340 Postrite®**  
6 piece cardboard display

Dimensions:  
7.7" (w) x 7.7" (d) x 9.45" (h)  
19.5cm (w) x 19.5cm (d) x 24cm (h)



**341 Postrite®**  
12 piece cardboard display

Dimensions:  
8.6" (w) x 7.9" (d) x 3.4" (h)  
22cm (w) x 20cm (d) x 9cm (h)



**929 Toolbox Level 10" (25cm)**  
15 piece cardboard display

Dimensions:  
11.4" (w) x 9.45" (d) x 11" (h)  
29cm (w) x 24cm (d) x 28cm (h)



**229 Toolbox Level 9" (23cm)**  
20 piece cardboard display

Dimensions:  
11.4" (w) x 9.45" (d) x 11" (h)  
29cm (w) x 24cm (d) x 28cm (h)



**846 Cyclops**  
10 piece cardboard display

Dimensions:  
4.5" (w) x 10" (d) x 5.1" (h)  
11.5cm (w) x 24cm (d) x 13cm (h)



## COUNTER DISPLAYS

### 318 Electrical Outlet Marker™

6 piece cardboard display

Dimensions:

15.7" (w) x 7.4" (d) x 12.2" (h)

40cm (w) x 19cm (d) x 31cm (h)



### 724 Cast Toolbox Level 10" (25cm)

12 piece display

Dimensions:

12" (w) x 9.45" (d) x 2" (h)

30cm (w) x 24cm (d) x 5cm (h)



### 246 HANDY LEVEL 10cm

10 piece cardboard display

Dimensions:

5.5" (w) x 4.7" (d) x 8.2" (h)

14cm (w) x 12cm (d) x 21cm (h)



### 313 Measure Mate 12" (30cm)

15 piece cardboard display

Dimensions:

11.8" (w) x 11.8" (d) x 15.7" (h)

30cm (w) x 30cm (d) x 40cm (h)

## FLOOR DISPLAYS

### 12 piece cardboard display built for the 770 Exodus.

Full color feature highlights. Easy set-up.

Available in 2 versions: 60cm, 80cm & 100cm lengths – (4 pieces each) & 100cm length which comes shrink wrapped with the 254 cutting knife - (12 pieces each)



### Kapro Specialist - 12 piece metal display for 4 specialty levels:

- Electrician  
783 Level 120cm – 3 pcs.
- Drywall  
773 Stud Layout Level 90cm – 3 pcs.
- Plumbing Installation  
108 70cm – 3 pcs.
- Mason - 920 SHARK®  
60, 80, 100cm – 1 pcs each length



**FLOOR DISPLAYS** Showcase Kapro's Advantages

313 Measure Mate  
up to 48" (120cm)  
15 piece cardboard  
display



24 piece metal  
display For Box and  
I-Beam levels 16"-  
48" (40cm-120cm).  
Ships flat, ready to  
assemble



Optivision Red Family  
Metal Floor Display  
Attractive full color  
branded display for  
all of Kapro's Optivision  
line of products -  
905, 930, 935  
Up to 42 products



12 piece metal display  
Ideally suited to the  
**Zeus™ 990**, this  
display has three  
steps, and holds four  
levels at each height,  
for maximum effect.  
Ships flat, ready to  
assemble

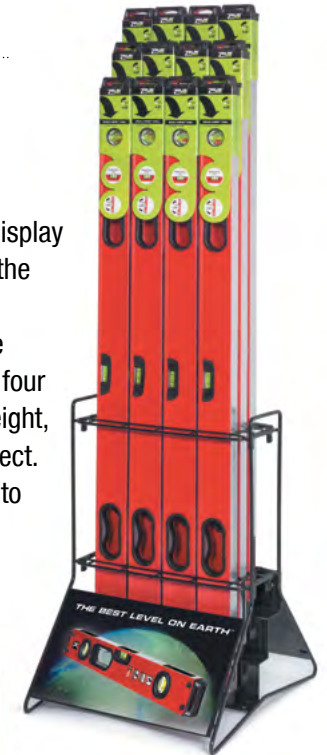

314-90 T-Square Work  
Center (120cm)  
10 piece cardboard  
display



12 piece metal display  
Designed for **985 Apollo™**  
Levels with bag (48"/120cm)  
Ships flat, ready to assemble



SKU Item #	PRODUCT NAME	PAGE
103	Inclinometer Gradient Level	34
104	Drainage Level	34
105	Topgrade™ Gradient Level	35
108	Box Level 70cm	36
130	Value I-Beam Level	21
150	Quality I-Beam Level	21
152, 153, 154, 155	Screeds & Screed Level	37
170	Samson™ Contractor I-Beam Level	20
201	Zinc Chalk Line	62
206	Folding Ruler	73
211	Plumb Bob Chalk Line	60
211S	Plumb Bob Chalk Line with Chalk	60
213	Ergonomic Chalk Line	61
214	Sure Grip Chalk Line & Level	61
222	Chalk Bottles	62
227	Toolbox Level 9" (23cm)	29
229	Toolbox Level 9" (23cm)	29
240/242	Surface Levels	38
245	Mini Level	38
246	Handy Level 4" (10cm)	30
275S/275	Carpenter's Sharpener & Pencils	72
301	T-Bevel	66
303	Ceramic Hole Marker	66
305,302	Framing Square, Stair Gauge	65
306, 308, 312	Aluminum Rulers & Straightedges	71

SKU Item #	PRODUCT NAME	PAGE
307	Try & Mitre Square	64
309	Ledgend™ Try & Mitre Square	64
313	Measure Mate	70
314	Set & Match® System	69
316	Drywall T-Square	68
317	Adjustable T-Square	68
318	Electrical outlet Marker	67
325	Magnetic Lock Combination Square	63
340	Postrite® Folding Post Level	31
341	Mini post Level	31
350	Pipe Level	30
352	Combination Square	63
375	KaproMeter K5	52
377	KaproMeter K7	53
383	KaproMeter K1	52
389	MultiScanner Stud Finder	51
440/441	Line Levels	38
444	Ergocast™ Rafter Square	65
500	Steel Power Tape	70
601	Measuring wheels	73
608	Framing Tape Measure	72
630	Telescopic Aluminum Ruler	67
660	Open Reel Tapes	73
720	Supercast™ Mason's Level	24
724	Kapro Value Cast Toolbox Level	28

SKU Item #	PRODUCT NAME	PAGE
730	Topcast	25
770	EXODUS 90cm	19
773	Stud Layout Level 90cm	18
779	Spirit™ Quality Box Level	17
781P	Genesis™ Contractor Box Level	16
783	Electrician's Level	35
810	Prolaser® Nail Gripper	51
814	Prolaser® Set-A-Shelf	55
820	Supercast™ Mason's Level	25
840	Beamfinder Glasses	57
841	Tripod adaptor	46
845	Laser Target	57
846	Cyclops	27
862	Mini Cross Line Laser	48
872	Prolaser® Plus	46
872G	Prolaser® Plus- Green	47
873	Prolaser® Plus Vector	45
875	Prolaser® Layout Set	42
875S	Prolaser® Layout Set	43
883	PROLASER® 3D ALL-LINES	44
886-48/38	Tripod for Laser Level	56
886-10	Leveling Disk for Laser Level	57
886-20	Laser Angle Mount	57
886-23	Universal Wall mount	57
886-30	Extendable Mounting Pole for Laser Level	56

SKU Item #	PRODUCT NAME	PAGE
886-58	Pole with Tripod	56
891	Prolaser® Laser Square	51
893	T-Laser	54
894-04	Laser Detector	57
896	Prolaser® 5-Dot	49
899	Prolaser® Self-leveling Rota-Line	50
905	Condor Professional Box Level with OPTIVISION™ Red	14
920	Shark®	24
923	Cast Toolbox Level 10" (25cm)	26
925	Topclass magnetic torpedo level	33
929	Toolbox Level 10" (25cm)	28
930	SmartCast Level with OPTIVISION™ Red	23
935	OPTIVISION RED Torpedo	26
946	Smarty	27
950	Swivel Plumb Site 50cm	22
985D	Digiman® Digital Level	32
985XL	Apollo™ Professional Box Level	15
992	Digital bevel	33
995	VULCAN The Next Generation	13
990	Zeus™ Professional Box Level	12



[www.kapro.com](http://www.kapro.com)  
E-mail: [quality@kapro.com](mailto:quality@kapro.com)

Cat No.: CT 30.079/A